

GE+ vAC/DC Full ePlus



Regenerative AC/DC Grid Emulator

The GE+ vAC/DC Full is the most complete and flexible Voltage Source, for AC and DC Test Platforms. Based on a Regenerative and Bidirectional power hardware, it is an essential laboratory device for testing and R&D applications in Renewable Energy Sources (PV, WT, CHP), grid connected devices, Smartgrids, Batteries, Electrical Vehicles and EV Chargers and Power HiL.



Regenerative Technology

Thanks to our bi-directional topology, the AC/DC Grid Emulator Converter are regenerative, resulting in a reduction of both the consumed energy during the tests and the power required from the electrical installation.

This technology allows us to work in both directions, as power generators or offering a consumption for the realization of all types of tests.

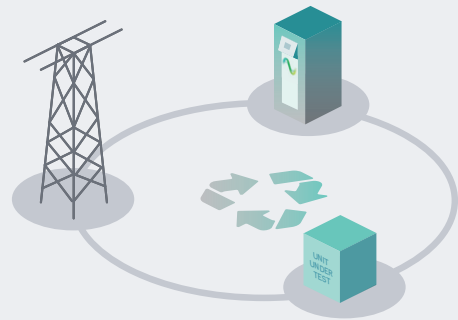

Main Applications



Electromobility



Smart Grids



Academic & RCP



IEC Testing

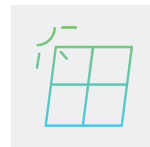

Photovoltaic

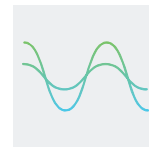

Industrial Test



Power HiL

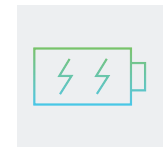

Energy Storage System

Bidirectional and Regenerative

Clean grid current

THDi < 3% and PF > 0.98

13 Models

from 7.5kW to 160kW

Parallelization of units to increase the power

Generation of Worldwide Electrical Grids

3-phase/ 1-phase/ split phase/ Multichannel

Independent Phase Configuration of

voltage rms, phase angle, frequency and harmonics

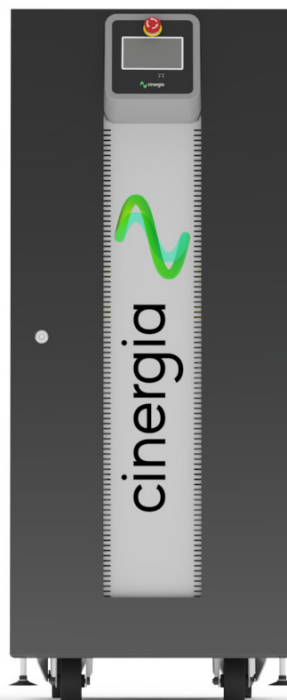

Same Power in DC and AC

Generation of Disturbances

harmonics, interharmonics, subharmonics, voltage dips frequency variation, flicker

Disturbance Generation Editor

compatible with IEC, LVRT, SEMI-F47, CBEMA test standards

Intuitive User Interface

Modbus/Ethernet Open protocol, Labview drivers

Bidirectional and Regenerative Hardware

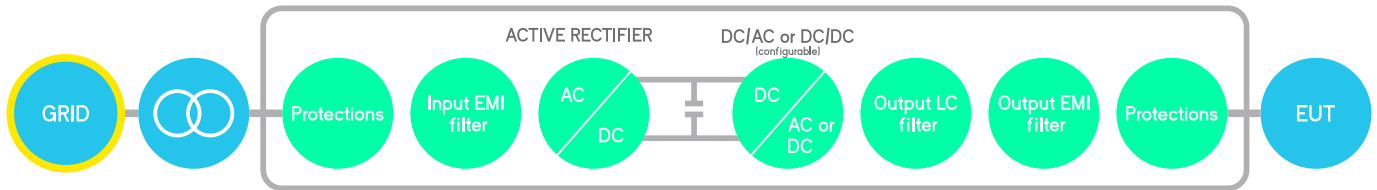

The hardware platform is based on a Back-to-Back power conversion topology, formed by two IGBT-based power stages. The grid side stage is an Active Rectifier which produces clean sinusoidal currents with very low harmonic distortion and power factor close to one.

The EUT side stage can be configured for AC voltage source or AC current source or DC output. In AC, voltage/current are controlled by using state of the art digital Proportional-Resonant controllers. In DC, the three independent buck-boost bidirectional legs enable the separated control of three different DC voltages or currents.

Block Diagram

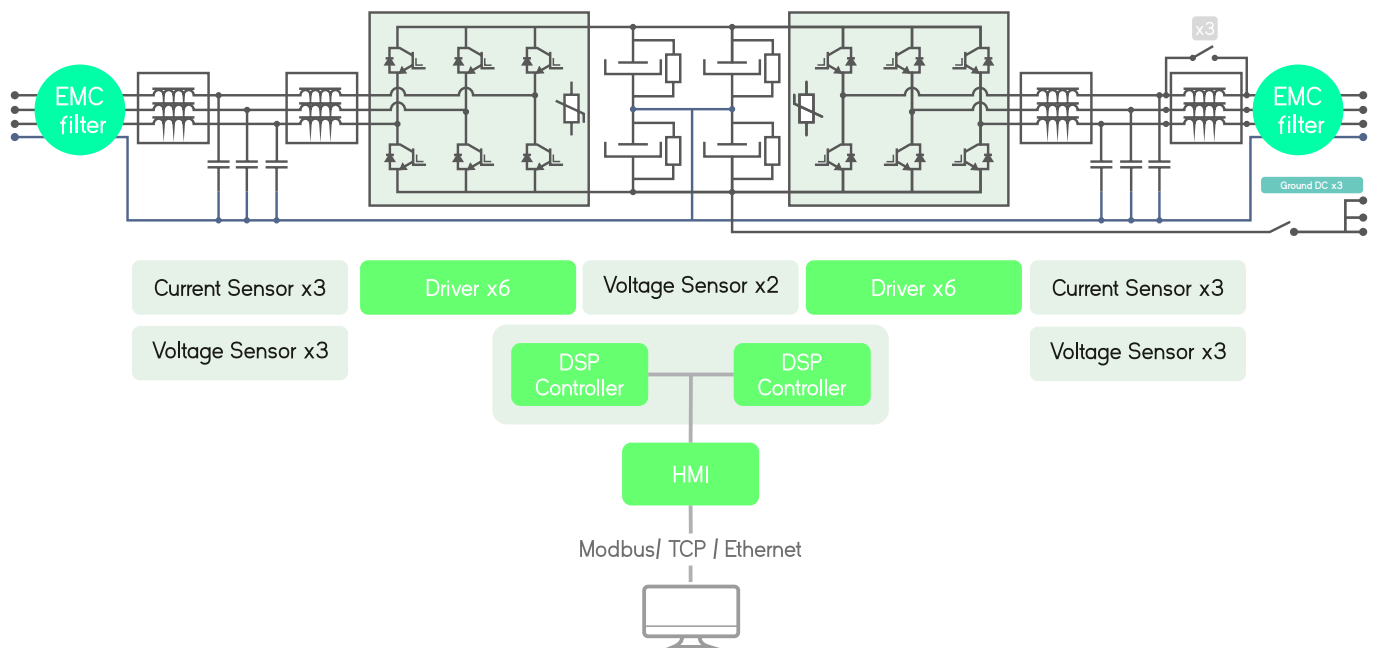

Local Interface

Analogue and Digital 10 ports

The isolated digital and analogue inputs/outputs permit the connection of the unit to External Controllers and Power Hardware in the Loop systems (option).

4.3" Touchscreen

Allows the local parameterization and command of the device, configuration of the communications link, plots the main signals and enables the local datalogging.

Safety First

The units integrate a local Emergency Stop pushbutton and two signals (input+ output) to be connected to the laboratory interlock system. Additionally, the digital outputs can be interfaced to safety tower lights.

Master/Slave

ePLUS is a modular platform enabling the master/slave connection of units with equal power.



Better than ever, the enhanced **Plus** family



What's better

MASTER/SLAVE CONNECTION

by using a fiber optics link to increase power/voltage capabilities:

GE in AC: can be connected in parallel

EL in AC: can be connected in parallel

B2C: can be connected in parallel, or series or both

FASTER

30kHz control loop frequency

MORE HARMONICS

50 per phase with 20 free-harmonics

DELTA LOAD

for the EL in AC mode

ADJUSTABLE DC TRANSIENT

controllers to improve stability of the system

OPTIMIZED RMS CALCULATION

for PV inverters anti-islanding test

SAME ELECTRICAL RATINGS

and SAME BANDWIDTH

because the power platform does not change so robustness and ratings remain the same.

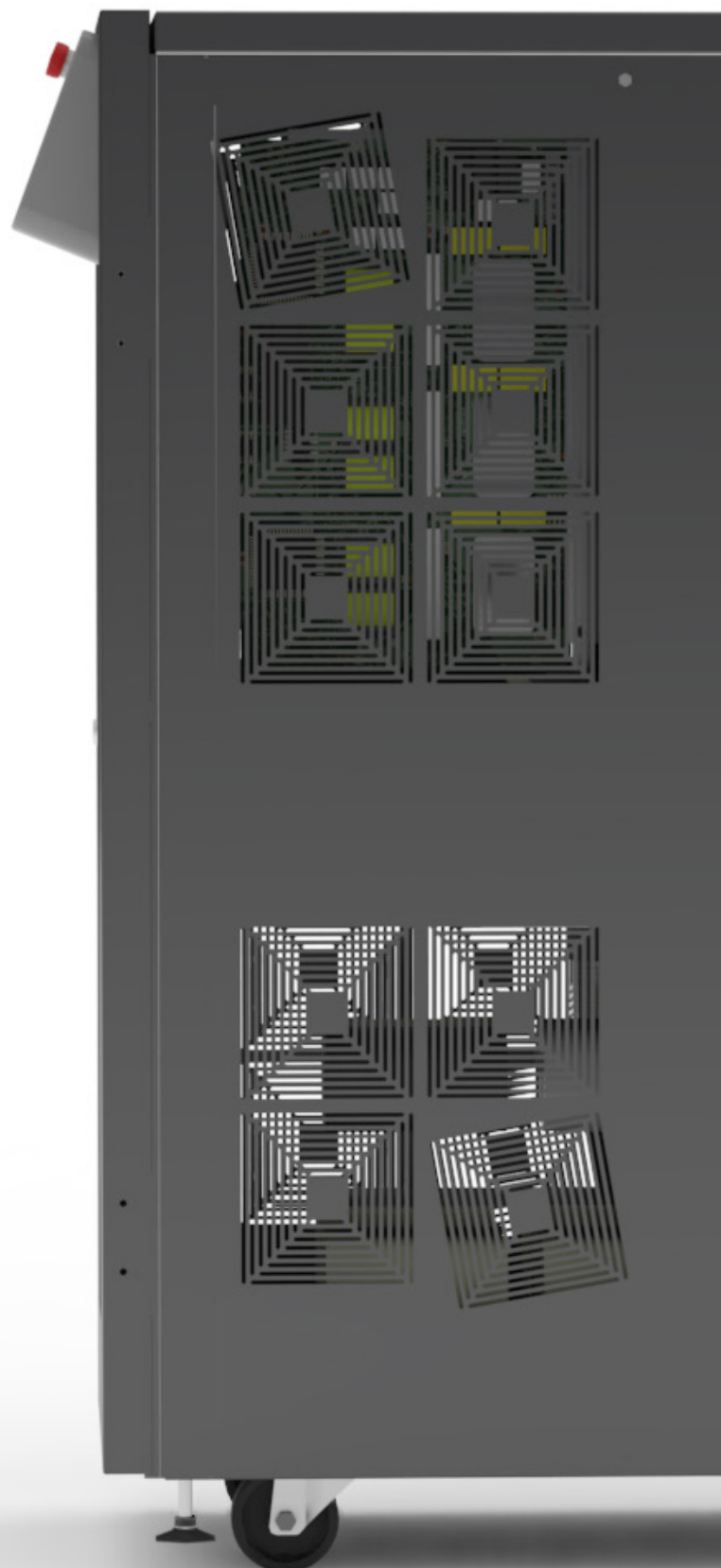

Software



The user interface used by CINERGIA devices has been developed by our R&D team, to offer total control of the device, with a comfortable and intuitive design. This allows us to take full advantage of the capabilities of the device, as well as the programming and execution of standardized or self-created tests.

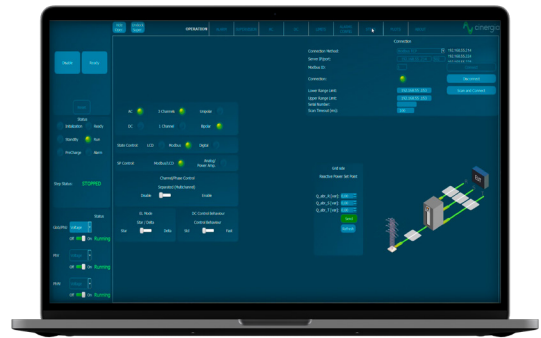

GE Modes



AC Operation

From this panel, the user can set all AC parameters. Each phase can be independently configured: RMS current magnitude, phase delay, harmonics content, free-frequency harmonic and transition ramps. A plot shows the expected real-time waveform, the FFT representation and the numeric data: RMS, peak, CF and THD.



Harmonics

The device can control simultaneously the magnitude of the first 15 harmonics and one free harmonic per phase. The free one allows the generation of sub-harmonics, inter-harmonics and high frequency harmonics up to the 50th, setting both the magnitude and phase delay.

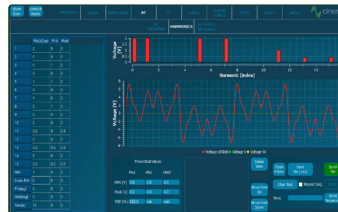

Parallel Mode

The device can be controlled in parallel mode where all phases are short-circuited internally. This mode it's suitable for single-phase applications. To increase the total power of the solution, the device can be connected in parallel* with multiple devices.

*For this connection contact us.

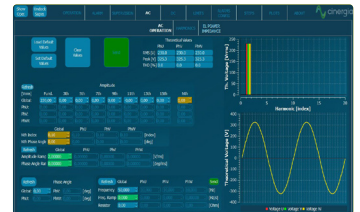

AC



Steps Mode

One of the most remarkable novelties of the new software is the steps functionality. Step test files are saved and executed by the DSP allowing deterministic timing with a resolution of 66µs. The user gains access to all registers of the device to create complex test sequences which run directly in the converter without the need of an external computer.

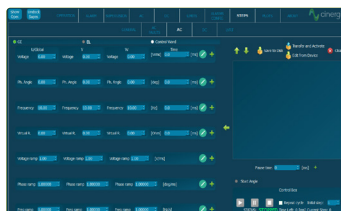

Disturbance Generation

The steps mode includes predefined easy-to-use test panels. The AC faults panel is a powerful yet intuitive editor which allows generating and configuring flicker. Specific profiles can be saved in .csv files, modified, and reused by importing an existing one.



IEC Testing

Optional

The last version of software includes a library supporting IEC standard for pre-compliance tests. The profiles defined in the standards are preloaded in the software for a user friendly execution and edition. Currently the following standards are available:

- IEC61000-4/11
- IEC61000-4/13
- IEC61000-4/14
- IEC61000-4/28

*It is mainly intended for pre-compliance testing. Contact us for further information.



DC

DC Operation

This panel allows the user to access all DC setpoints and limits. Thanks to the unique Multichannel feature, each phase can have a different Operation Mode: voltage, current, power, resistance and advanced DC applications. Transition ramps, voltage and current limits can be modified. The limits for sink and source operation are different for safer testing, specially in battery applications.



Sequence

The User Interface Software integrates a Sequence Editor to create automatic test sequences, save them for future use and import them in .csv files. A smart datalogger can be activated from the LCD of the unit to record automatically the resulting voltage and current measurements with a time resolution of 400 ms.

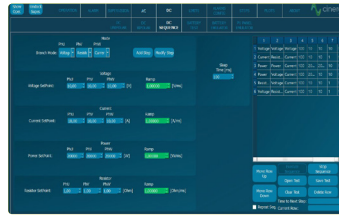

Multichannel

Enabling the Separated Channel Control converts the device in three functionally independent DC Bidirectional Power Supplies, sharing the common negative rail. Each channel can have a different status (ON, OFF, Warning, Alarm), Operation Mode (see Range and Specifications table), Setpoint, Ramp and Limits.



Battery Pack Tester

This functionality enables the user to precisely control the charge, discharge and cycling of a Battery. Basic parameters include the charge/discharge current, fast charge and floating voltages while Advanced parameters add Energy (Ah) and Time as transition conditions. Profiles for each Battery technology can be saved and imported in .CSV files.



Battery Emulation

The B2C+ integrates a mathematical model to emulate the voltage behaviour of a real battery pack. The output voltage will change as a function of the SOC and Current. By configuring the provided parameters, the voltage profile can be adjusted to match different technologies: Lilon, NiMH, NiCd, Pb, Flux, etc.

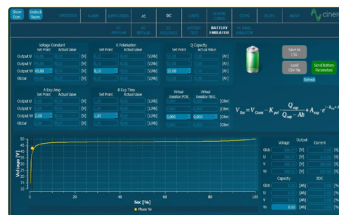

PV Panel Emulation

The PV Panel model is based on the single-diode equivalent circuit of a PV cell and the series-parallel connection of cells to form a panel. A Runtime functionality allows the simulation of a complete day by launching different irradiance and temperature setpoints from a .csv file, enabling the user burn-in and functional tests of PV Inverters.

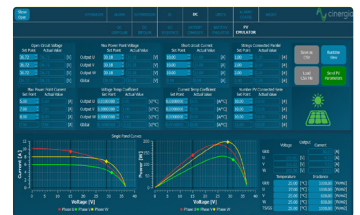

GE+ vAC/DC Range & Specifications

Input side (GRID side)

AC Voltage

Rated: $3 \times 400 \text{V}_{\text{rms}}$ +Neutral+ Earth
Range: +15% / -20%

Rated AC Current

Depends on model (see Wiring Manual)

Frequency

48-62Hz

Current Harmonic Distortion

THDi < 3% at rated power

Current Power Factor

PF > 0.98 at rated power

Efficiency

$\geq 89\%$ (7.5 & 10), $\geq 91\%$ (15 to 30), $\geq 92\%$ (40 to 200)

Output side in DC (EUT side)

Terminals

Number: 4 (3 phases + 1 neutral)

Configuration of Channels

Unipolar 3-channels 2Q, independent setpoints per channel

Unipolar 1-channel 2Q, one global setpoint for all channels

Multichannel: 2Q, independent start/stop, operation mode and setpoints per channel (note: multichannel is an option for $\geq 80 \text{kVA}$)

Bipolar (4Q two independent setpoints)

Voltage (CV)

Range: 2Q: $20^{(1)}$ to 750V (800V with High Voltage option)

4Q: 0 to +350V / 0 to -350V (+ rail / 0 / - rail, Bipolar configuration)

Setpoint Resolution: 10mV

Effective Resolution⁽²⁾: < 0.05% of FS⁽³⁾

Setpoint Accuracy⁽⁴⁾: $\pm 0.1\%$ of FS⁽³⁾

Transient Time⁽⁵⁾: < 1ms (10% to 90% at a step to V_{rated})

Ripple⁽⁷⁾ (peak-peak): < 0.55% of FS⁽³⁾

Current Mode (CC)

Range: from 0 to $\pm 110\%$ of I_{rated} (see models table)

Setpoint Resolution: 10mA

Effective Resolution⁽²⁾: < 0.05% of FS⁽³⁾ (< 0.1% models 7.5 & 10)

Setpoint Accuracy⁽⁴⁾: $\pm 0.2\%$ of FS⁽³⁾

Transient Time⁽⁵⁾: < 1ms (10% to 90% at a step to I_{rated})

Ripple⁽⁷⁾ (peak-peak): < 0.7% of FS⁽³⁾

Power Mode (CP)

Range: from 0 to $\pm 200\%$ ⁽⁸⁾ of P_{rated} (see models table)

Derived current setpoint: $P_{\text{setpoint}} / V_{\text{measured}}$

Setpoint Resolution: 1W

Effective Resolution⁽²⁾: < 0.1% of FS⁽³⁾ (< 0.25% models 7.5 & 10)

Setpoint Accuracy⁽⁴⁾: $\pm 0.4\%$ of FS⁽³⁾

Transient Time⁽⁵⁾: < 2.5ms (10% to 90% at a step to P_{rated})

Resistance Mode (CR)

Range: from 0.1 to 1000 Ohm

Derived current: $V_{\text{measured}} / R_{\text{setpoint}}$

Setpoint Resolution: 0.01 Ohm

Setpoint Accuracy⁽⁴⁾: $\pm 0.2\%$ of FS⁽³⁾

Transient Time⁽⁵⁾: < 2ms (10% to 90% at a step to R_{rated})

Output side in AC (EUT side)

Terminals

Number: 4 (3 phases + 1 neutral)

Configuration of Channels

3 channels: 4Q, independent setpoints per phase

1 channel: 4Q, global setpoints for all phases (only in GE+)

Multichannel: 4Q, independent start/stop, alarm status and setpoints per phase (note: multichannel is an option for $\geq 80\text{kVA}$)

Output side in GE-AC

Voltage Mode (CV)

Peak: $\pm 400\text{V}$ phase-neutral

Range: $0^{(1)}$ to 277Vrms phase-neutral (295Vrms with HV option)
 $0^{(1)}$ to 480Vrms phase-phase (510Vrms with HV option)

THDv: $< 0.1\%$ rated linear load at 230Vrms , $50/60\text{Hz}$
 $< 0.9\%$ rated non linear load $\text{CF}=3$ at 230Vrms , $50/60\text{Hz}$

Setpoint Resolution: 10mVrms

Effective Resolution⁽²⁾: $< 0.05\%$ of FS⁽³⁾

Setpoint Accuracy⁽⁴⁾: $< \pm 0.1\%$ of FS⁽³⁾

Transient Time⁽⁵⁾: $< 1.5\text{ms}$ (10% to 90% at a step to V_{rated})

Ripple⁽⁷⁾ (peak-peak): $< 0.55\%$ of FS⁽³⁾

Enhanced

Harmonics

Range: up to 50th (at $50/60\text{Hz}$ fundamental)

50 independent harmonics per phase:

20 free programmable frequency and phase from 0.1 to 50 times f_0

30 fixed frequency

Harmonics content: $V \cdot f < 46000$ (with current derating)

Setpoint Accuracy⁽⁴⁾: same as voltage accuracy

Small Signal Bandwidth: up to $5000\text{Hz}^{(9)}$

Transient Time⁽⁵⁾: $< 2\text{ms}$ (10% to 90% at a step change)

Frequency

Fundamental Frequency Range: 10 to 100Hz (up to 400Hz option)

Small Signal Bandwidth: up to $5000\text{Hz}^{(9)}$

Resolution: 1mHz

Phase Angle

Range: 0 to 360°

Resolution: 0.01°

Operation Modes

DC

Programmable Voltage (CV)

Programmable Current (CC)

Programmable Power (CP)

Programmable Resistance (CR)

Power Amplifier (HiL)

Steps

Optional Battery Testing (BTest) (charge/discharge/cycling)

Optional Battery Emulation (BEmu)

Optional PV Panel Emulation (PVEmu)

AC

Programmable Voltage (CV) (only in GE+)

Power Amplifier (HiL)

Steps

Optional LVRT, IEC 61000 -4-11, 4-13, 4-14, 4-28

Overload/ Overcurrent

Admissible DC overcurrent is: 110% of rated value during 1 minute

Admissible AC overcurrent: 125% of rated value during 10 minutes,

150% during 1 minute, 200% during 2 seconds

Admissible overloads: 125% of rated value during 10 minutes,

150% during 1 minute, 200% during 2 seconds

User Interface

Local Control (4.3" Touchscreen panel)

Isolated Digital port: 6 inputs, 4 outputs
 Isolated Analogue port: 6 inputs (rms setpoints or power amplifier), 6 outputs (rms readback or real-time readback)
 Interlock port: 1 NC Input, 1 NO Output
 Emergency Stop pushbutton

Emergency Stop pushbutton

Touchscreen panel

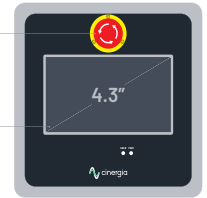

Remote Control Port

LAN Ethernet with Open Modbus-TCP protocol
 RS485 (option), CAN and RS232 (using external gateway)

Software

Graphical User Interface for Windows 7/10
 LabView drivers and open Labview interface example

Enhanced

Master/Slave Operation

Connection: fiber optics link (x6)
 Configuration: from software user interface/MODBUS up to 8 units:
 AC: Parallel
 DC: Parallel, serial or serial-parallel

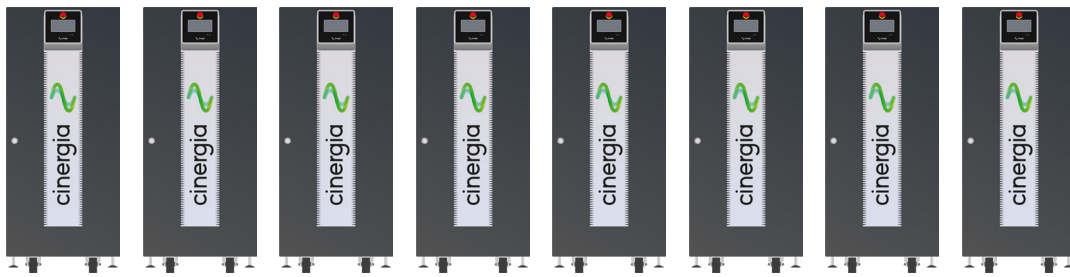

Size and Weight

Models 7.5 to 60 kW

Height

1100 mm

Width

450 mm

Depth

770 mm

Weight

200 kg

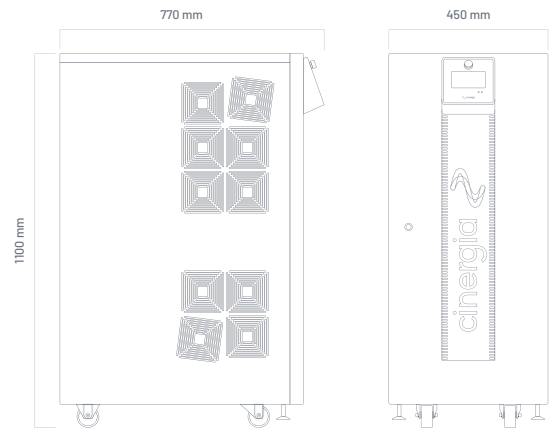

Models 80 to 120 kW

Height

1320 mm

Width

875 mm

Depth

870 mm

Weight

400 kg



Models 160 & 200 kW

- Height**
2000 mm
- Width**
900 mm
- Depth**
850 mm
- Weight**
680 kg

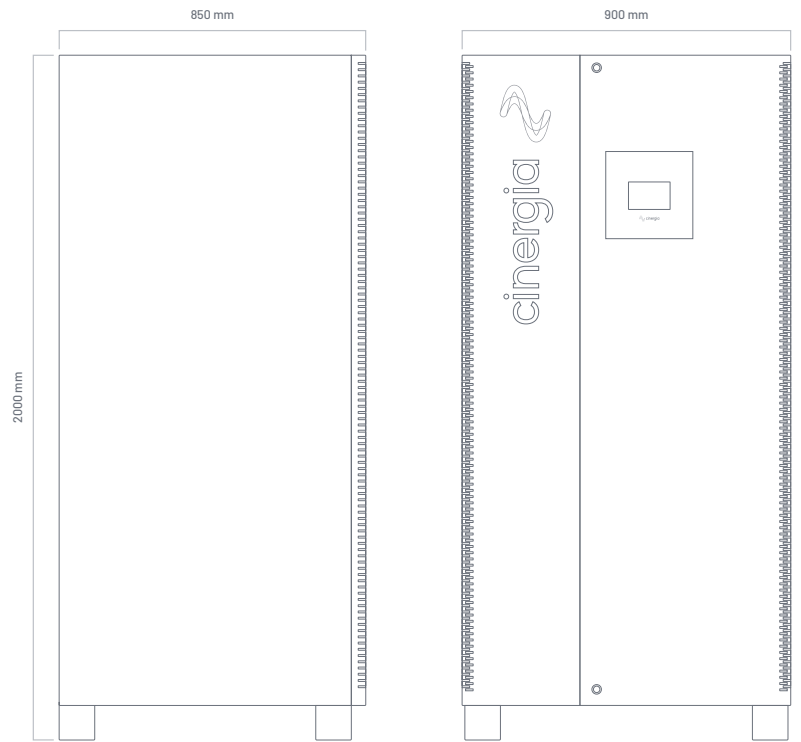

Connections

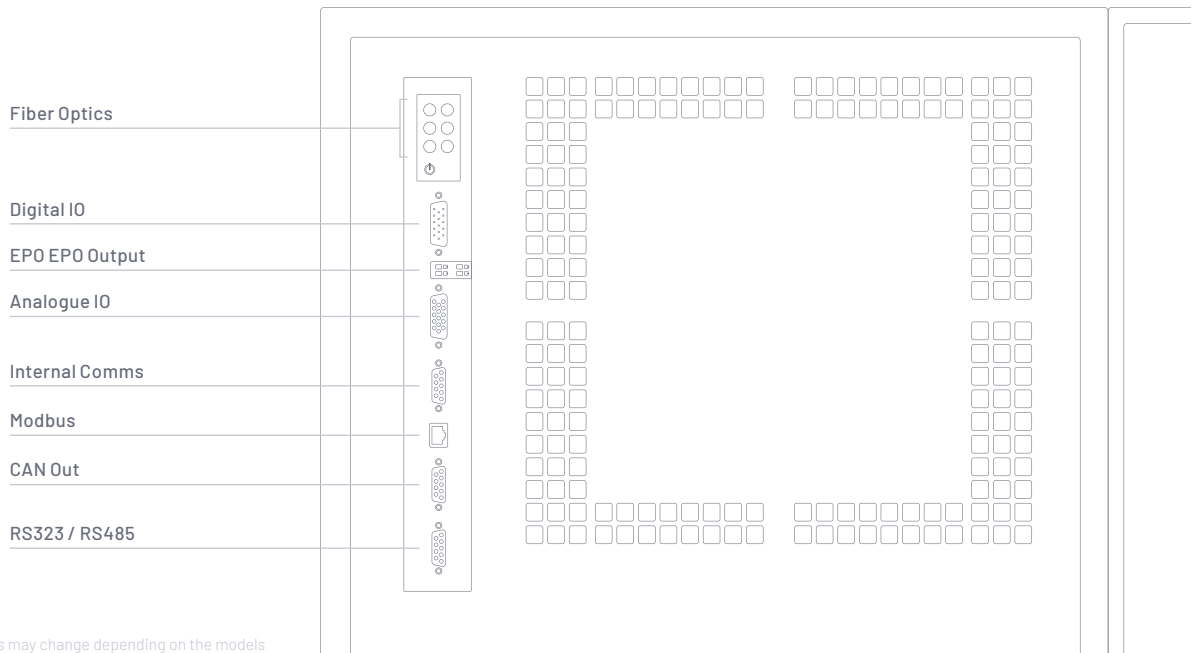

The distribution of the connectors may change depending on the models

Selectors

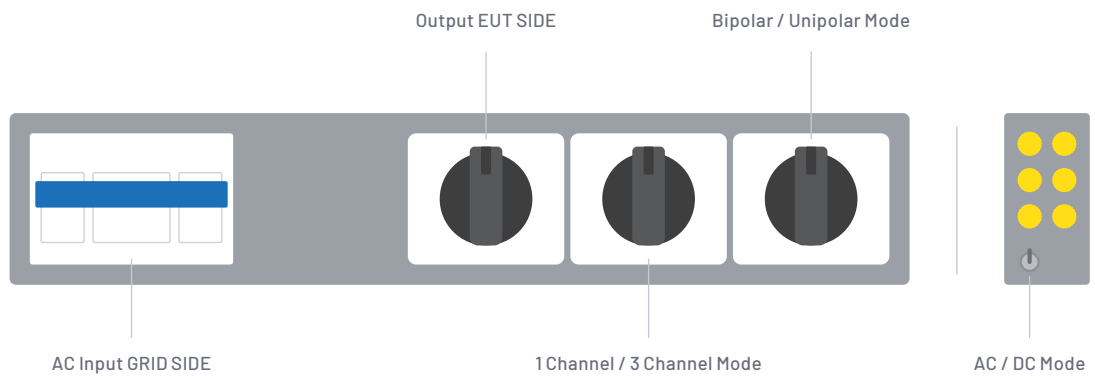

The type of selectors and their location may change depending on the models

Protections

Overvoltage (peak, rms), Overcurrent (peak, rms), Overload
Shortcircuit, Emergency Stop, Watchdog, Heart Beat, Output
Contactar, Wrong Configuration
Alarms and Limits are user configurable and can be saved in a
password protected EEPROM

Mesurements ⁽⁶⁾

Grid Voltage (rms), Current (rms), Power (P,O) and Frequency
Output Voltage (rms, avg), Current (rms, avg), Power (P,O) and Frequency
Heatsink Temperatures (x2) and DC Link Voltage
Datalogging available through FTP connection

Ambient

Operating temperature⁽⁶⁾: 5-40°C
Relative Humidity: up to 95%, non-condensing
Cooling: Forced air
Acoustic noise at 1m: < 52dB(A)(7.5 to 60), < 65dB(A)(80 to 120), < 70dB(A)(160 and 200)

Standards

CE Marking
Operation and Safety: EN-50178, EN-62040-1
EMC: EN-62040-2
RoHS

All specifications are subject to change without notice.

Options

Choose your options:

- Three channel mode: allows different operation mode start/stop/reset per channel (included in all models from 7.5 to 60, both included)
- 30kHz Switching Frequency: only available for models 15 (derated to 7.5kW), 20 (derated to 7.5kW) and 30 (derated to 10kW)
- Isolation monitor (advised for IT systems)
- Low voltage ripple capacitance
- Anti-islanding monitor (only advised in net injection to the grid and following local regulations)
- High Voltage (HV): voltage up to 295Vrms phase-neutral
 - in AC up to 800V in DC
 - RS485
 - Battery Emulation
 - Battery Test
 - PV Panel Emulation
 - Predefined Tests: LVRT, IEC 61000-4-11, 4-13, 4-14, 4-28 (consult us for specific Test)

All specifications are subject to change without notice.

1. Minimum voltage setpoint is 0V in DC. The recommended minimum setpoint for long-term use is 20Vrms in AC and 20V in DC,
2. Effective resolution measured with a 400ms window
3. FS Range of voltage is 800V (with High Voltage option)
FS Range of current is 2-13 · I rated I (see models table)
FS Range of power is 2-1200% · Prated I (see models table)
4. Accuracies are valid for settings above 10% of FS
5. Measured with the rated resistive load and high-dynamics controllers configuration.
6. Accuracy of measurements is ±0.1% of FS for rms voltage, ±0.2% of FS for rms current, ±0.4% of FS for active power (valid only above 10% of FS)
7. Consult us for lower voltage/current ripple requirements
8. Rated power figures are given at 20°C
9. The maximum output voltage depends on frequency following $V_f < 46000$

Models

GE+ vAC/DC Full

Reference	AC Power Rated ⁽⁹⁾	AC Current Rated ⁽⁹⁾ RMS 3 channels / 1 channel	DC Power Rated ⁽⁹⁾	DC Current Rated ⁽⁹⁾ RMS 3 channels / 1 channel	Weight (kg)	Dimensions DxWxH (mm)
GE+ 7.5 vAC/DC	7.5 kW	11 A / 33A	7.5 kW	±10A / ±30A	155 kg	770 x 450 x 1100 mm
GE+ 10 vAC/DC	10 kW	15 A / 45 A	10 kW	±15A / ±45A	155 kg	770 x 450 x 1100 mm
GE+ 15 vAC/DC	15 kW	22 A / 66 A	15 kW	±20A / ±60A	155 kg	770 x 450 x 1100 mm
GE+ 20 vAC/DC	20 kW	29 A / 87 A	20 kW	±25A / ±75A	155 kg	770 x 450 x 1100 mm
GE+ 30 vAC/DC	27 kW	40 A / 120 A	27 kW	±30A / ±90A	155 kg	770 x 450 x 1100 mm
GE+ 40 vAC/DC	40 kW	58 A / 174 A	40 kW	±40A / ±120A	200 kg	770 x 450 x 1100 mm
GE+ 50 vAC/DC	50 kW	73 A / 219 A	50 kW	±50A / ±150A	200 kg	770 x 450 x 1100 mm
GE+ 60 vAC/DC	54 kW	80 A / 240 A	54 kW	±57A / ±171A	200 kg	770 x 450 x 1100 mm
GE+ 80 vAC/DC	80 kW	116 A / -	80 kW	±105A / ±315A	320 kg	870 x 590 x 1320 mm
GE+ 100 vAC/DC	100 kW	145 A / -	100 kW	±130A / ±390A	320 kg	870 x 590 x 1320 mm
GE+ 120 vAC/DC	108 kW	157 A / -	108 kW	±130A / ±390A	320 kg	870 x 590 x 1320 mm
GE+ 160 vAC/DC	145 kW	211 A / -	145 kW	±155A / ±465A	680 kg	850 x 900 x 2000 mm
GE+ 200 vAC/DC	160 kW	232 A / -	160 kW	±185A / ±555A	680 kg	850 x 900 x 2000 mm

All specifications are subject to change without notice.

Galvanic Isolation

	Circuit Breaker Recommended	Weight	
Inside the cabinet	IT 7.5i	Type C - 25 A	145 kg
	IT 10i	Type C - 25 A	145 kg
	IT 15i	Type C - 32 A	145 kg
	IT 20i	Type C - 40 A	145 kg
	IT 30i	Type C - 50 A	195 kg
	IT 40i*	Type C - 63 A	195 kg
	IT 50i*	Type C - 83 A	195 kg

*In the IT 40i and IT 50i models the size of the cabinet increases to a total of 770 x 835 x 1100 mm. The others keep the original size.

	Circuit Breaker Recommended	Weight	Dimensions D x W x H	
In external cabinet IP20	IT 30e	Type D - 80 A	174 kg	595 x 415 x 708 mm
	IT 40e	Type D - 100 A	217 kg	725 x 525 x 773 mm
	IT 50e	Type D - 125 A	280 kg	725 x 525 x 773 mm
	IT 60e	Type D - 160 A	381 kg	875 x 600 x 900 mm
	IT 80e	Type D - 200 A	435 kg	875 x 600 x 900 mm
	IT 100e	Type D - 250 A	458 kg	875 x 600 x 900 mm
	IT 120e	Type D - 315 A	514 kg	875 x 600 x 900 mm
	IT 160e	Type D - 400 A	612 kg	964 x 648 x 1252 mm
	IT 200e	Type D - 500 A	753 kg	1192 x 744 x 1430 mm

Configuration Modes



Master / Slave



Channel Configuration in GE

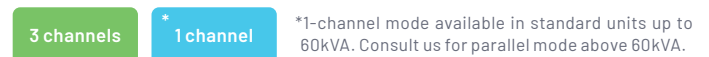

Channel Configuration in DC



Regenerative Power Electronic Solutions



Can Baletes 7, Nau A
08310 Argentona
Barcelona (Spain)
+34 934 864 358
cinergia@ciner giapower.com

Follow us on:
Youtube, LinkedIn, Twitter